

Les applications possibles sont :



Portails battants



Caractéristiques

- En cupro-aluminium
- Visserie en inox

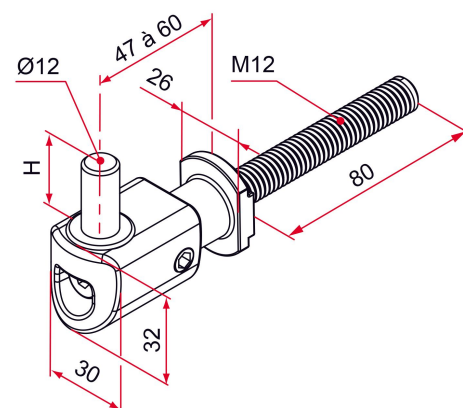

Produits à commander chez :
TIRARD SAS 16, Avenue du Vimeu Vert Z.A. du Vimeu Industriel 80210
FEUQUIERES-EN-VIMEU
email : commande@tirard-burgaud.com

Les applications possibles sont :



Portails battants



Référence	H	Finition	GENCOD 3661598	Condit. par	Délai j
NA692105	25	9005-80%	03928 4	25	7
NA691105	25	9016-80%	03927 7	25	7
NA619105	25	brut	03926 0	1	7
NA6XX105	25		03929 1	1	21
NA692205	35	9005-80%	03932 1	25	7
NA691205	35	9016-80%	03931 4	25	7
NA619205	35	brut	03930 7	1	7
NA6XX205	35		03933 8	1	21

Multi-RAL : préciser votre couleur à la commande (<https://www.couleursral.fr/ral-classic>)