

Possible applications include :



Wooden wing shutter accessories



PVC and Aluminum wing shutter accessories



Features

- Composite body Stainless steel 304 latch Stainless steel For shutters with thickness of 22 to 38 mm Wood screw (for wood support or composite plug installation)

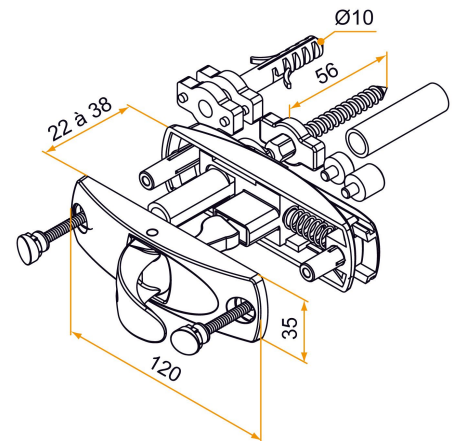

Products to be ordered from :
 BURGAUD SAS 147, rue des Paludiers Z.I. des Mares 85270 SAINT-HILAIRE-DE-RIEZ
 email : commande@tirard-burgaud.com

Possible applications include :



Wooden wing shutter accessories



PVC and Aluminum wing shutter accessories



Référence	Finish	GENCOD 3565920	Condit. par	Délai j
5AR16002	black	13507 4	30	7
5AR17002	white	13506 7	30	7

 Multi-RAL : specify your color when placing the order (<https://www.couleursral.fr/ral-classic>)