

Possible applications include :



Garage door accessories



Wing shutter and louver accessories



Features

- Made of steel



Tip

- The 3rd long point version is systematically delivered with the universal flat strike plate (ref.CE112001) to ensure guidance and retention. Please refer to the index.

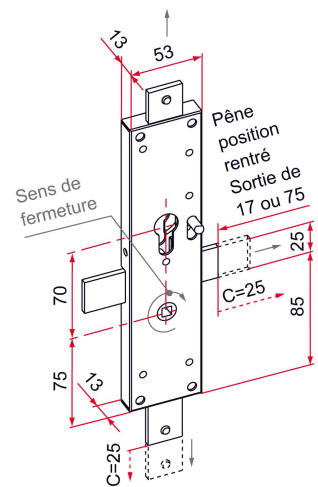

Products to be ordered from :
 TIRARD SAS 16, Avenue du Vimeu Vert Z.A. du Vimeu Industriel 80210
 FEUQUIERES-EN-VIMEU
 email : commande@tirard-burgaud.com

Possible applications include :



Garage door accessories



Wing shutter and louver accessories



Référence	No. and type of pin	Finish	GENCOD 3661598	Condit. par	Délai j
CE112107	2 points	Zn	00251 6	1	7
CE112111	3rd short point	Zn	00255 4	1	7
CE112109	3rd long point	Zn	00253 0	1	7

 Multi-RAL : specify your color when placing the order (<https://www.couleursral.fr/ral-classic>)