

Possible applications include :



Swinging gate accessories



Features

- Composite lock case and 304 stainless steel faceplate.
Reversible.



Tip

- For the colored versions, only the headplate is painted. To be able to mount the stops on the lock, add M5 at the end of the code.

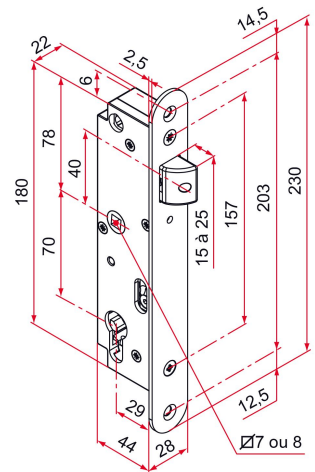

Products to be ordered from :
TIRARD SAS 16, Avenue du Vimeu Vert Z.A. du Vimeu Industriel 80210
FEUQUIERES-EN-VIMEU
email : commande@tirard-burgaud.com

Possible applications include :



Swinging gate accessories



Référence	Square spindle	Finish	GENCOD 3661598	Condit. par	Délai j
GK492001PCTP	7	9005-80%	04607 7	1	7
GK491001PCTP	7	9016-80%	04606 0	1	14
GK401001PCTP	7	brush	04604 6	1	7
GK4XX001PCTP	7		04608 4	1	21
GK492011PCTP	8	9005-80%	04611 4	1	7
GK491011PCTP	8	9016-80%	04610 7	1	14
GK401011PCTP	8	brush	04609 1	1	7
GK4XX011PCTP	8		04612 1	1	21

Multi-RAL : specify your color when placing the order (<https://www.couleursral.fr/ral-classic>)