

Possible applications include :



Sliding gate



Features

- Composite lock case Stainless steel 304 faceplate and bolt

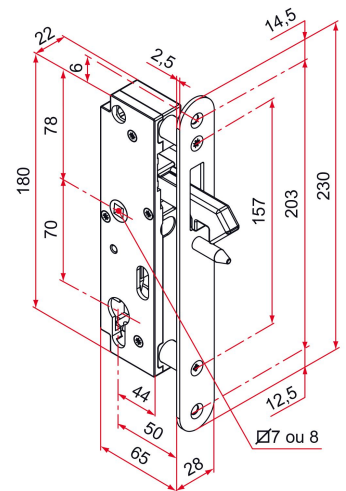

Products to be ordered from :
TIRARD SAS 16, Avenue du Vimeu Vert Z.A. du Vimeu Industriel 80210
FEUQUIERES-EN-VIMEU
email : commande@tirard-burgaud.com



GK lock with stainless steel lifting bolt - 50mm axis - round strike plate - recessed installation

Possible applications include :



Sliding gate



Référence	Square spindle	Headrest finish	GENCOD 3661598	Condit. par	Délai j
GK401203PZTP	7	brush	04651 0	1	7
GK401213PZTP	8	brush	04652 7	1	7

 Multi-RAL : specify your color when placing the order (<https://www.couleursral.fr/ral-classic>)