

Possible applications include :

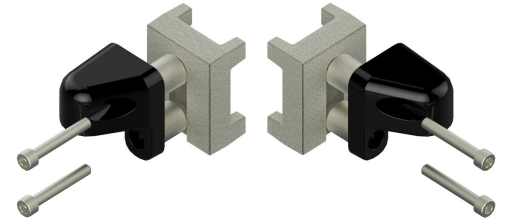

Swinging gate accessories



Features

- Aluminum ear Aluminum spacers and raw aluminum insert
- Composite anti-friction ring Ø12



Tip

- The screw-on ears with their fixing inserts are specific to certain integrated frame profiles on the market (please contact us). For a good hold of this joint on the leaf, it is imperative to install these ears with an insert in the integrated frame.

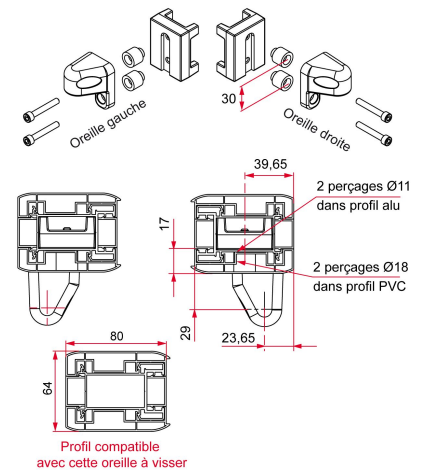

Products to be ordered from :
 TIRARD SAS 16, Avenue du Vimeu Vert Z.A. du Vimeu Industriel 80210
 FEUQUIERES-EN-VIMEU
 email : commande@tirard-burgaud.com

Possible applications include :



Swinging gate accessories

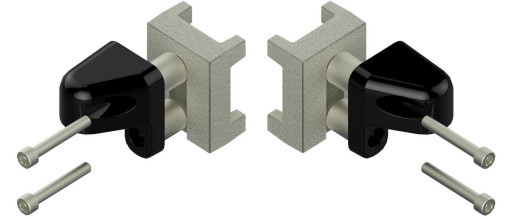

Référence	Ear	Finish	GENCOD 3661598	Condit. par	Délai j
NE692208	LEFT	9005-80%	04820 0	1	14
NE691208	LEFT	9016-80%	04821 7	1	14
NE619208	LEFT	raw	04819 4	1	7
NE692108	RIGHT	9005-80%	04823 1	1	14
NE691108	RIGHT	9016-80%	04824 8	1	14
NE619108	RIGHT	raw	04822 4	1	7

Multi-RAL : specify your color when placing the order (<https://www.couleursral.fr/ral-classic>)