

Possible applications include :

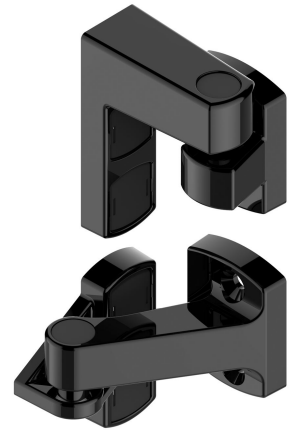

Swinging gate accessories



Features

- Stainless steel 304

ATTENTION

- The raw parts must be painted.

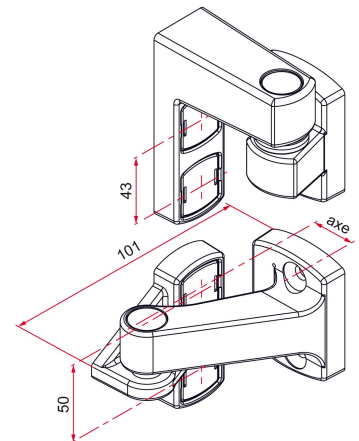

Products to be ordered from :
 TIRARD SAS 16, Avenue du Vimeu Vert Z.A. du Vimeu Industriel 80210
 FEUQUIERES-EN-VIMEU
 email : commande@tirard-burgaud.com

Possible applications include :



Swinging gate accessories

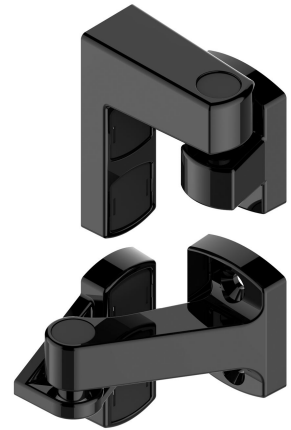

Référence	Finish	Composite part	GENCOD 3661598	Condit. par	Délai j
GDN011N53	9005-30%	black	05454 6	1	21
GDN011B68	9016-80%	white	05470 6	1	21
GDN011B63	9016-30%	white	05453 9	1	21
GDN011B03	9010-30%	white	05493 5	1	21
GDN011G7016FT	7016-fine texture	gray	05455 3	1	21
GDN011	raw	gray	05452 2	1	7
GDN011RAL		black	05466 9	1	21

Multi-RAL : specify your color when placing the order (<https://www.couleursral.fr/ral-classic>)