

Possible applications include :

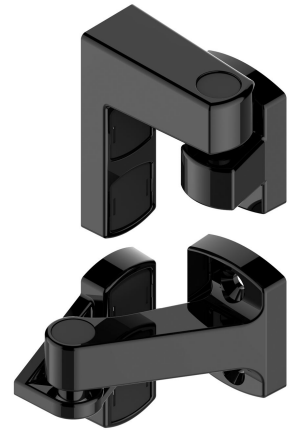

Swinging gate accessories



Features

- Stainless steel 304

ATTENTION

- The raw parts must be painted.

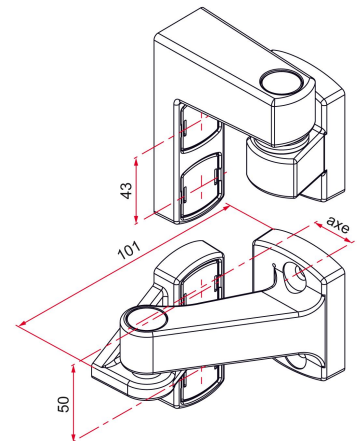

Products to be ordered from :
 TIRARD SAS 16, Avenue du Vimeu Vert Z.A. du Vimeu Industriel 80210
 FEUQUIERES-EN-VIMEU
 email : commande@tirard-burgaud.com

Possible applications include :



Swinging gate accessories

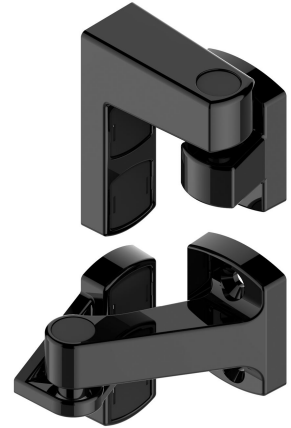

Référence	Finish	Composite part	GENCOD 3661598	Condit. par	Délai j
GDN013N53	9005-30%	black	05463 8	1	21
GDN013B68	9016-80%	white	05472 0	1	21
GDN013B63	9016-30%	white	05462 1	1	21
GDN013B03	9010-30%	white	05495 9	1	21
GDN013G7016FT	7016-fine texture	gray	05464 5	1	21
GDN013	raw	gray	05461 4	1	7
GDN013RAL		black	05465 2	1	21

Multi-RAL : specify your color when placing the order (<https://www.couleursral.fr/ral-classic>)