

Les applications possibles sont :



Volets battants bois



Volets battants PVC
et aluminium



Caractéristiques

- Corps en composite
- Gâche en inox 304
- Inoxydable
- Pour volet épaisseur 22 à 38 mm
- Tire-fond (vissage support bois ou cheville composite)

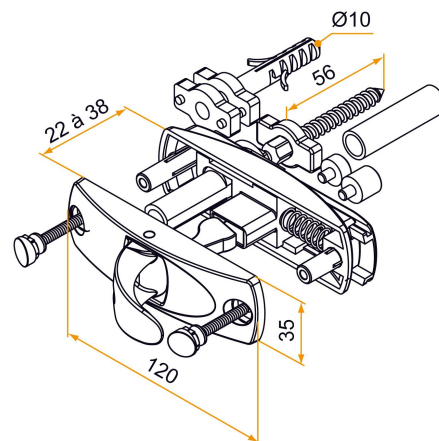

Produits à commander chez :
BURGAUD SAS 147, rue des Paludiers Z.I. des Mares 85270 SAINT-HILAIRE-DE-RIEZ
email : commande@tirard-burgaud.com

Les applications possibles sont :



Volets battants bois



Volets battants PVC et aluminium



Référence	Finition	GENCOD 3565920	Condit. par	Délai j
5AR16002	noir	13507 4	30	7
5AR17002	blanc	13506 7	30	7

 Multi-RAL : préciser votre couleur à la commande (<https://www.couleursral.fr/ral-classic>)