

Les applications possibles sont :



Portails battants



Caractéristiques

- En cupro-aluminium
- Visserie en inox

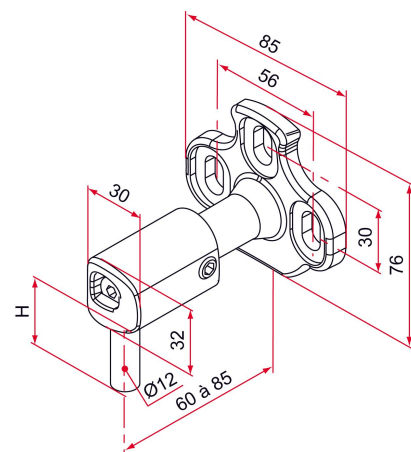

Produits à commander chez :
TIRARD SAS 16, Avenue du Vimeu Vert Z.A. du Vimeu Industriel 80210
FEUQUIERES-EN-VIMEU
email : commande@tirard-burgaud.com

Les applications possibles sont :



Portails battants



Référence	H	Finition	GENCOD 3661598	Condit. par	Délai j
NA692107	25	9005-80%	03944 4	25	14
NA691107	25	9016-80%	03943 7	25	14
NA619107	25	brut	03942 0	1	7
NA6XX107	25		03945 1	1	21
NA692207	35	9005-80%	03948 2	25	14
NA691207	35	9016-80%	03947 5	25	14
NA619207	35	brut	03946 8	1	7
NA6XX207	35		03949 9	1	21

Multi-RAL : préciser votre couleur à la commande (<https://www.couleursral.fr/ral-classic>)