

Les applications possibles sont :



Portails battants



Caractéristiques

- En cupro-aluminium
- Visserie en inox

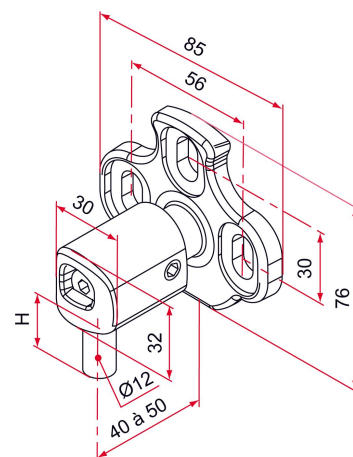

Produits à commander chez :
TIRARD SAS 16, Avenue du Vimeu Vert Z.A. du Vimeu Industriel 80210
FEUQUIERES-EN-VIMEU
email : commande@tirard-burgaud.com

Les applications possibles sont :



Portails battants



Référence	H	Finition	GENCOD 3661598	Condit. par	Délai j
NA692109	25	9005-80%	04449 3	25	14
NA691109	25	9016-80%	04450 9	25	14
NA619109	25	brut	04448 6	1	7
NA6XX109	25		04451 6	1	21
NA692209	35	9005-80%	04457 8	25	14
NA691209	35	9016-80%	04458 5	25	14
NA619209	35	brut	04456 1	1	7
NA6XX209	35		04459 2	1	21

Multi-RAL : préciser votre couleur à la commande (<https://www.couleursral.fr/ral-classic>)