

Les applications possibles sont :



Volets battants PVC et aluminium



Caractéristiques

- En aluminium

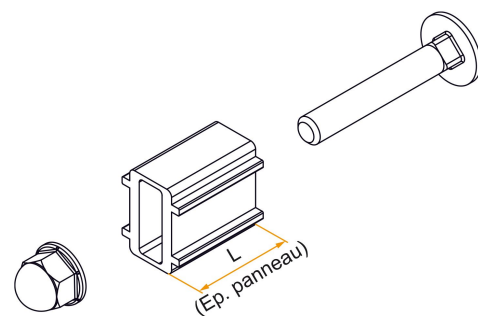

Produits à commander chez :
BURGAUD SAS 147, rue des Paludiers Z.I. des Mares 85270 SAINT-HILAIRE-DE-RIEZ
email : commande@tirard-burgaud.com

Les applications possibles sont :



Volets battants PVC et aluminium



Référence	L	Finition	GENCOD 3565920	Condit. par	Délai j
KIU001N53	20	9005-30%	19606 8	100	21
KIU001B68	20	9016-80%	19612 9	100	21
KIU001RAL	20		19622 8	1	21
KIU002N53	24	9005-30%	19607 5	100	14
KIU002B68	24	9016-80%	19613 6	100	14
KIU002RAL	24		19623 5	1	14
KIU003N53	27	9005-30%	19609 9	100	14
KIU003B68	27	9016-80%	19614 3	100	14
KIU003RAL	27		19624 2	1	14
KIU004N53	28	9005-30%	19610 5	100	14
KIU004B68	28	9016-80%	19615 0	100	14
KIU004RAL	28		19625 9	1	14
KIU005N53	30	9005-30%	19611 2	100	14
KIU005B68	30	9016-80%	19616 7	100	14
KIU005RAL	30		19626 6	1	14

Multi-RAL : préciser votre couleur à la commande (<https://www.couleursral.fr/ral-classic>)