

Les applications possibles sont :



Portes de garages



Volets battants bois



Volets battants PVC et aluminium



Volets battants et persiennes



Volets coulissants



Menuiserie et agencement



Caractéristiques

- En inox

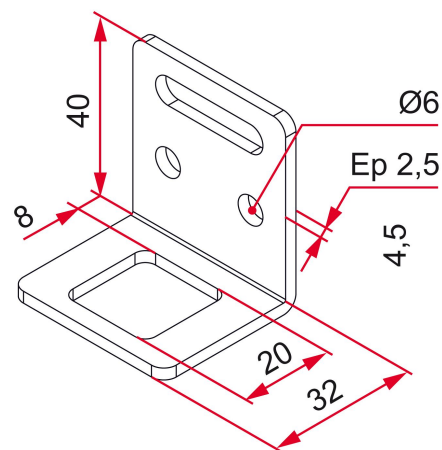

Produits à commander chez :
 TIRARD SAS 16, Avenue du Vimeu Vert Z.A. du Vimeu Industriel 80210
 FEUQUIERES-EN-VIMEU
 email : commande@tirard-burgaud.com

Les applications possibles sont :



Portes de garages



Volets battants bois



Volets battants PVC et aluminium



Volets battants et persiennes



Volets coulissants



Menuiserie et agencement



Référence	Finition	GENCOD 3661598	Condit. par	Délai j
GAN001N53	9005-30%	04966 5	1	7
GAN001B68	9016-80%	04965 8	1	7
GAN001B03	9010-30%	04964 1	1	7

Multi-RAL : préciser votre couleur à la commande (<https://www.couleursral.fr/ral-classic>)