

Les applications possibles sont :



Volets battants bois



Volets battants PVC
et aluminium



Menuiserie et
agencement

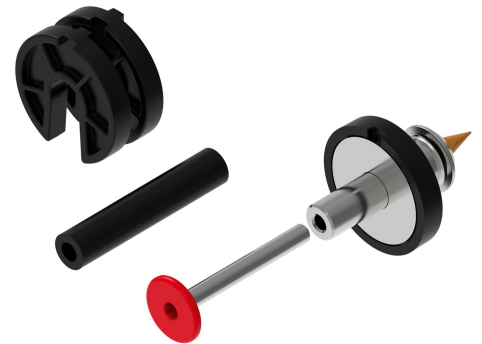

Caractéristiques

- Composition :
- 1 axe de butée en inox 304
- 1 entretoise anti-écrasement en composite
- 2 cales en composite
- 1 rondelle en élastomère
- 1 rondelle en inox 304
- 1 crayon de bois
- 1 vis réglable en inox 304

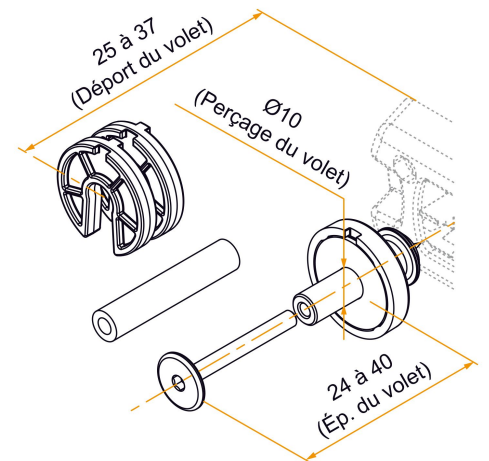

Les applications possibles sont :

Volets battants bois

Volets battants PVC
et aluminiumMenuiserie et
agencement

Produits à commander chez :
BURGAUD SAS 147, rue des Paludiers Z.I. des Mares 85270 SAINT-HILAIRE-DE-RIEZ
email : commande@tirard-burgaud.com

Les applications possibles sont :



Volets battants bois



Volets battants PVC
et aluminium



Menuiserie et
agencement



Référence	Finition	Pièce composite	GENCOD 3565920	Condit. par	Délai j
ARP004N53	9005-30%	noir	21676 6	30	21
ARP004B68	9016-80%	blanc	21677 3	30	21
ARP004AN	brut	noir	21681 0	30	21
ARP004AB	brut	blanc	21680 3	30	21
ARP004ANRAL		noir	21679 7	1	21
ARP004ABRAL		blanc	21678 0	1	21

Multi-RAL : préciser votre couleur à la commande (<https://www.couleursral.fr/ral-classic>)